

OUTLINE

TF-5000 / 6000 series are Thermal Mass Flowmeters, which measure mass flow rate of various kinds of gas free from the change of process condition such as pressure and temperature.

TF-5000 / 6000 cover from 0 to 5 mL/min(nor), to 0 to 500 L/min(nor). Scale range and maximum 32 MPa pressure to meet almost all possible applications.

FEATURES

- ❑ Wide Range
With the full scale range of 5 mL/min(nor) to 500 L/min(nor) and the maximum operation pressure of 32 MPa, the mass flowmeter covers a wide range of applications from mounting onto laboratory equipment, analyzers, etc. to process control.
- ❑ High Accuracy
TF-5000 / 6000 offer $\pm 1.0\%$ (F.S.) accuracy.
- ❑ High Reliability
TOKYO KEISO long time experience of Thermal Theory Flow Measurement guarantees reliability and durability.
- ❑ Supporting Instruments
TM3000 convertor unit is available for easy system configuration.

OPERATION PRINCIPLE

The gas to be measured is directed to by-pass sensing path by flow restriction. At the by-pass sensing path, two resistance coils are wound which consist a bridge circuit with resistance circuit in electric compartment.

In case of no flow passing through the by-pass sensing path, the bridge circuit is in balanced condition.

When the gas moves, the heat at the upstream coils is transferred to downstream coil and thus upsetting the original heat balance.

Then, the bridge circuit outputs electric signal. Theoretically, the heat transfer is proportional to the moving mass of the gas to be measured and its specific heat. The specific heat of the gas is not affected by its pressure and within reasonable range of temperature, it can be observed to be as stable.

Thus, by measuring the heat transfer through bridge output, the mass flow rate of the gas can be measured. The output signal from the bridge circuit is amplified to 0 to 5V DC.

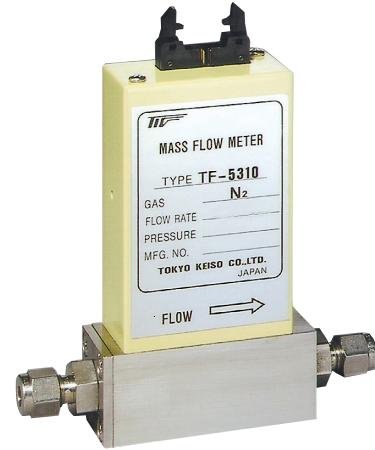

MODEL CODE

Model Code				Description
TF-	3	0-	A,B,C	
Press rating	5			General Use
	6			High Press. Use
Size	1			Very small Flow use
	2			Small Flow use
	3			Medium Flow use
	4			Large Flow use
Scale Range		A,B,C		Full scale
Connection Type			P	Rc Screw
			N	NPT(F)
			S	Swagelok
			R	VCR
			O	VCO
			F	JIS10K Flange
Connection Size			0.4	1/4"
			0.6	3/8"
			0.8	1/2"
			1.2	3/4"
			1.6	1"

Subject to Press rating & size. Refer to ■ STANDARD SPECIFICATION for details

*①A scale range is shown by the exponential expression as the unit of multiplier unit of mL/min (nor).

Example)

0 to 5mL/min(nor) 0|5|0 (5×10⁰)

0 to 500mL/min(nor) 5|0|1 (50×10¹)

0 to 1L/min(nor) 1|0|2 (10×10²)

0 to 300L/min(nor) 3|0|4 (30×10⁴)

*②Dimension and model code are varied depending on the scale range.

· Scale range 0 to 20L/min(nor) : TF-5310/TF-6310



· More than 20 to 80L/min(nor) : TF-5320/TF-6320

· More than 80 to 300L/min(nor) : TF-5330/TF-6330

· More than 300 to 500L/min(nor) : TF-5340/TF-6340

(Flow rate has been converted to that of N₂ gas.)

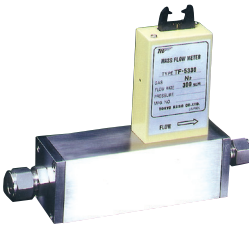
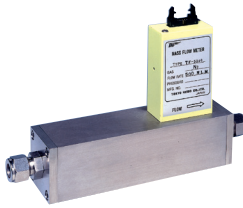

STANDARD SPECIFICATION

MODEL		TF-5310	TF-5320	TF-5330	TF-5340
					
MEASURING FLUID		Gases (excluding chlorine, acid, sulfur, and other corrosive gases) Contact us for the applicability of the flowmeter to less common gases.			
SCALE RANGE ^{*1}	Min.	0 to 5 mL/min (nor)	0 to 20 L/min (nor)	0 to 80 L/min (nor)	0 to 300 L/min (nor)
	Max.	0 to 20 L/min (nor)	0 to 80 L/min (nor)	0 to 300 L/min (nor)	0 to 500 L/min (nor)
OUTPUT SIGNAL		0 to 5 V DC (Linear to 0 to 100% of Scale range)			
ACCURACY		±1.0% F.S. (at RT standard) RT: Ambient temperature of 25°C ±5°C at the adjustment			
RESPONSE SPEED		90% within 3sec.			
GAS PRESS		-0.03 to 0.98 MPa			
TEMP. RANGE (GAS & AMBIENT)		5 to 50°C			
TEMP. CHANGE EFFECT		For span		±0.1% F.S./°C Max.	
		For zero		±0.05% F.S./°C Max.	
PRESS. CHANGE EFFECT		±0.1% F.S./0.1 MPa Max. *2			
POWER SUPPLY (TO DETECTOR)		+15 V DC, 25 mA Max. -15 V DC, 5 mA Max.			
MATERIAL (GAS CONTACT)		Tube SUS316, Sealing FKM or CR			
PROCESS CONNECTION	THREADS	Rc1/4, 1/4NPT	Rc1/4, 3/8, 1/2, 1/4, 3/8, 1/2NPT	Rc3/8, 1/2, 3/4 or 1 3/8, 1/2, 3/4 or 1NPT	
	FITTINGS	OD1/4, 3/8, 1/2 SWAGELOK *3		OD3/8, 1/2, 3/4 SWAGELOK *3	
	FLANGES	JIS10K 15 A to 25 A			

*1: Flow rate of Nitrogen(N₂).
See P.6 for conversion factors.

*2: Effect of pressure change on N₂ gas. The pressure effect varies with the operating pressure and kind of fluid when the pressure exceeds 1 MPa. (TF-63□0)

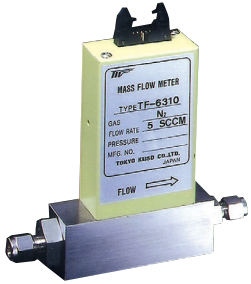
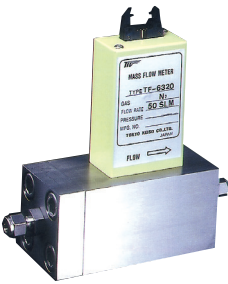
*3: VCR and VCO are available on request.

MODEL		TF-6310	TF-6320	TF-6330	TF-6340
					
MEASURING FLUID		Gases (excluding chlorine, acid, sulfur, and other corrosive gases) Contact us for the applicability of the flowmeter to less common gases.			
SCALE RANGE ^{*1}	Min.	0 to 5 mL/min (nor)	0 to 20 L/min (nor)	0 to 80 L/min (nor)	0 to 300 L/min (nor)
	Max.	0 to 20 L/min (nor)	0 to 80 L/min (nor)	0 to 300 L/min (nor)	0 to 500 L/min (nor)
OUTPUT SIGNAL		0 to 5 V DC (Linear to 0 to 100% of Scale range)			
ACCURACY		±1.0% F.S. (at RT standard) RT: Ambient temperature of 25°C ±5°C at the adjustment			
RESPONSE SPEED		90% within 3 sec.			
GAS PRESS		-0.03 to 32 MPa ^{*4}			
TEMP. RANGE (GAS & AMBIENT)		5 to 50°C			
TEMP. CHANGE EFFECT		For span		±0.1% F.S./°C Max.	
		For zero		±0.05% F.S./°C Max.	
PRESS. CHANGE EFFECT		±0.1% F.S./0.1 MPa Max. ^{*2}			
POWER SUPPLY (TO DETECTOR)		+15 V DC, 25 mA Max. -15 V DC, 5 mA Max.			
MATERIAL (GAS CONTACT)		Tube SUS316, Sealing FKM or CR			
PROCESS CONNECTION	THREADS	Rc1/4, 1/4NPT	Rc1/4, 3/8, 1/2 1/4, 3/8, 1/2NPT	Rc3/8, 1/2 3/8, 1/2	
	FITTINGS	OD1/4, 3/8 SWAGELOK ^{*3}	OD1/4, 3/8, 1/2 SWAGELOK ^{*3}	OD1/4, 3/8, 1/2, 3/4 SWAGELOK ^{*3}	OD3/8, 1/2, 3/4 SWAGELOK ^{*3}
	FLANGES	Not Available			

*4: Flow rate calibration is conducted at a pressure of up to 9.8 MPa.

When higher pressures are specified, a pressure test is conducted at the specified operating pressure, and flow rate calibration is conducted based on theoretical compensation calculation.

The maximum operating pressure is restricted for some gases. For example, the maximum operating pressure of CO₂ is limited to 3 MPa. Confirm the physical properties of the measuring gas beforehand.

DIMENSIONS

TF-5310

Rc connection

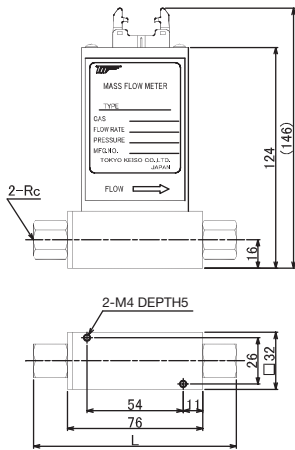

Size	L
Rc1/4	114
Rc3/8	120
Rc1/2	128

SWL connection

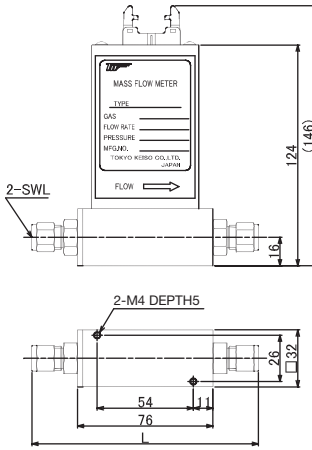

Size	L
1/4SWL	127
3/8SWL	130
1/2SWL	134

VCR connection

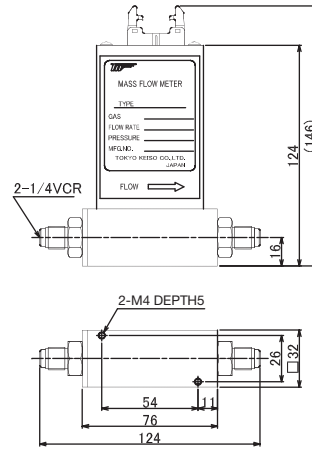

JIS 10K FLANGE

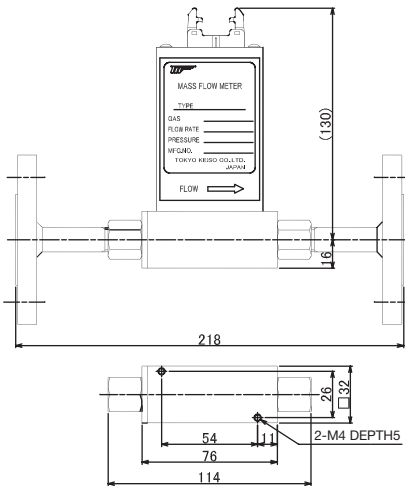

Size	15A	20A	25A
Type	JIS 10K (FF) (RF)		

TF-5320

Rc connection

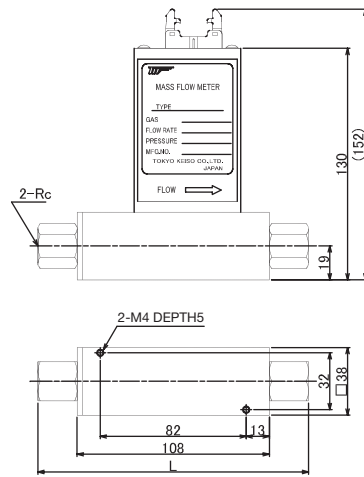

Size	L
Rc1/4	146
Rc3/8	152
Rc1/2	160

SWL connection

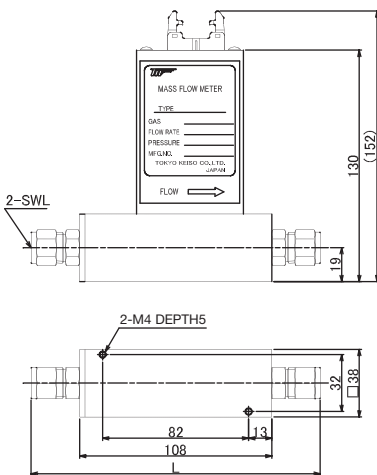

Size	L
1/4SWL	159
3/8SWL	162
1/2SWL	166

VCR connection

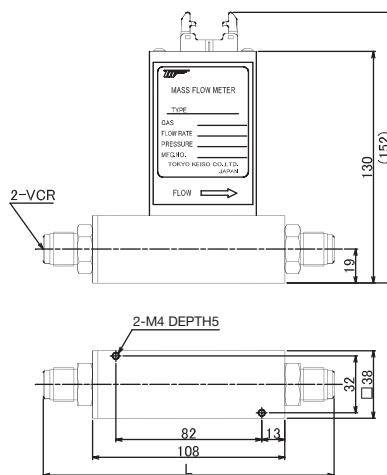

Size	L
1/4VCR	156
3/8VCR	163
1/2VCR	163

JIS 10K FLANGE

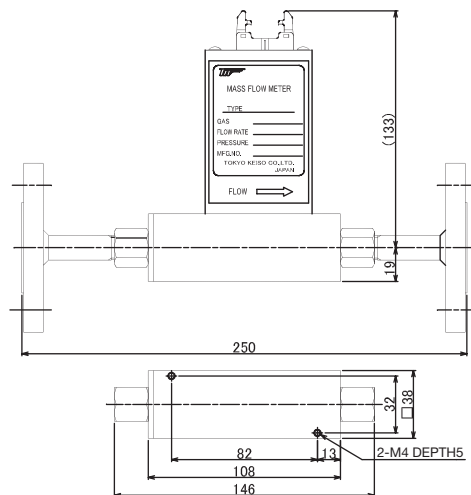

Size	15A	20A	25A
Type	JIS 10K (FF) (RF)		

TF-5330/TF-5340
Rc connection

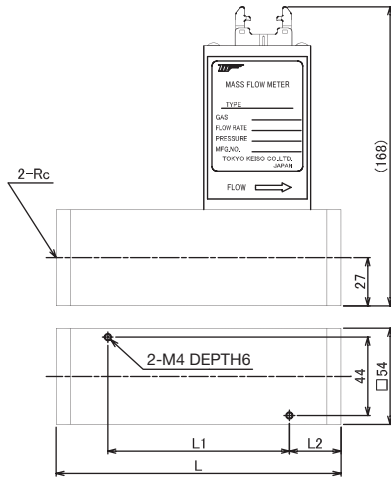

Size	Rc3/8	Rc1/2	Rc3/4	Rc1	Rc3/8	Rc1/2	Rc3/4	Rc1
L1 / L2	102 / 29			140 / 30				
L	160			200				
Model	TF-5330			TF-5340				

SWL connection

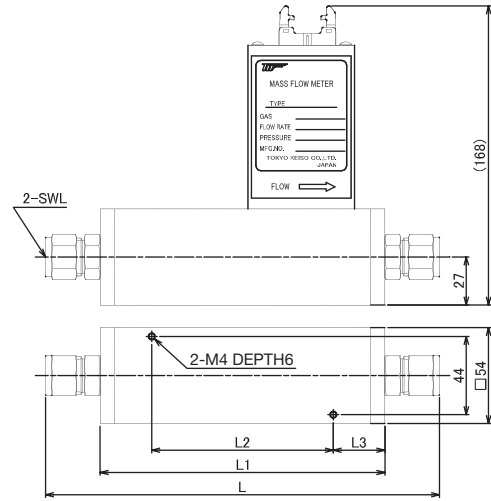

Size	3/8SWL	1/2SWL	3/4SWL	3/8SWL	1/2SWL	3/4SWL
L2 / L3	102 / 29			140 / 30		
L1	160			200		
L	216	221	230	256	261	270
Model	TF-5330			TF-5340		

VCR connection

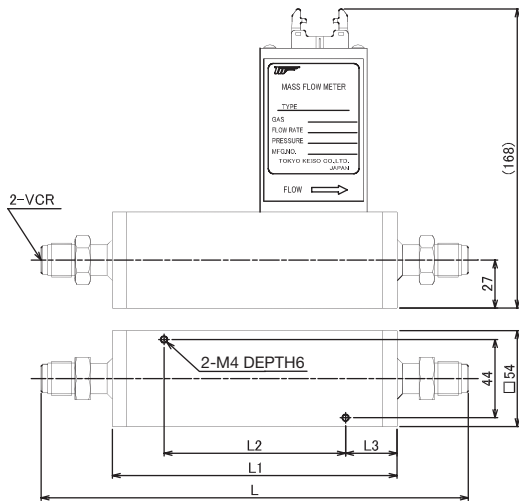

Size	3/8VCR	1/2VCR	3/4VCR	3/8VCR	1/2VCR	3/4VCR
L2 / L3	102 / 29			140 / 30		
L1	160			200		
L	240	260	280	300		
Model	TF-5330			TF-5340		

JIS 10K FLANGE

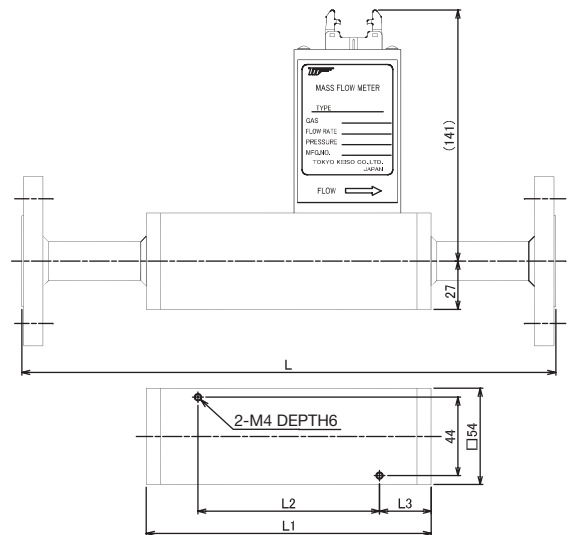

Size	15A	20A	25A	15A	20A	25A
Type	JIS 10K (FF) (RF)					
L2 / L3	102 / 29			140 / 30		
L1	160			200		
L	300			340		
Model	TF-5330			TF-5340		

TF-6310
Rc screw
connection

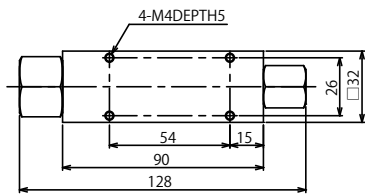
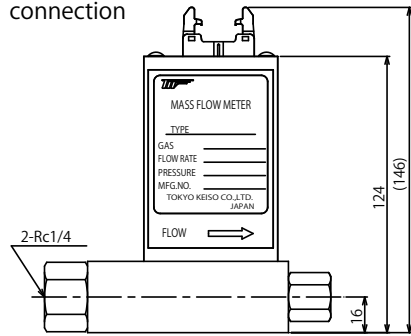

TF-6310
SWL
connection

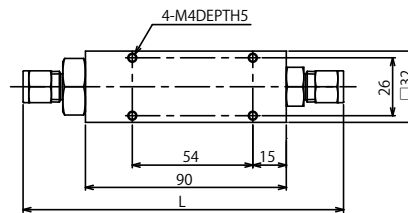
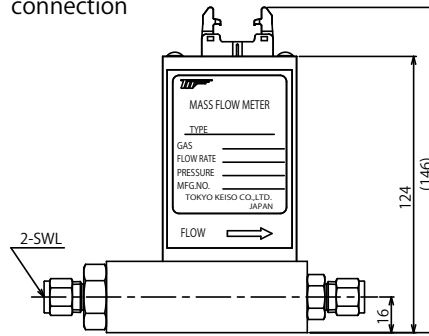

CONNECTION	L
1/4SWL	144
3/8SWL	147

TF-6320
Rc screw
connection

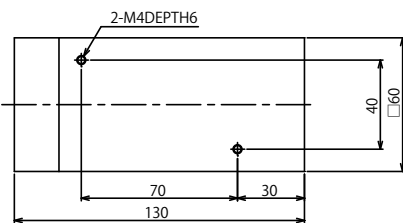
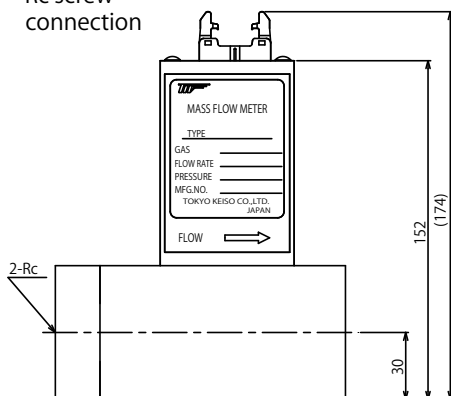

CONNECTION	L
Rc1/4	
Rc3/8	
Rc1/2	

TF-6320
SWL connection

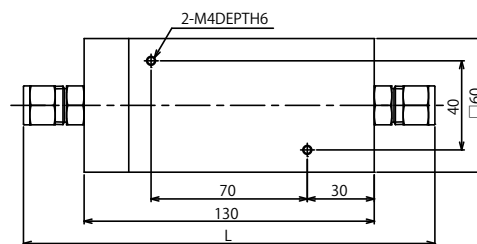
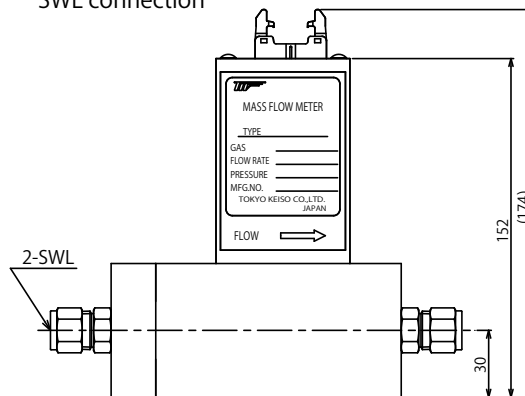

CONNECTION	L
1/4SWL	181
3/8SWL	184
1/2SWL	188

TF-6330
Rc screw
connection

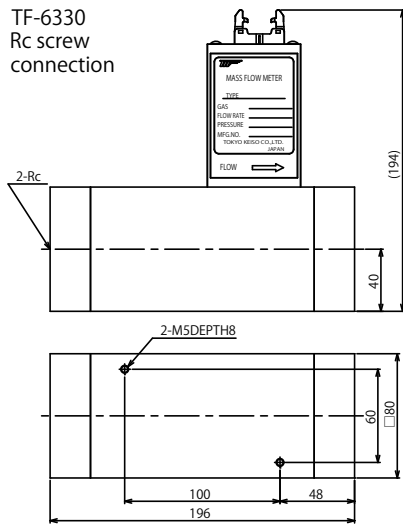

CONNECTION
Rc3/8
Rc1/2

TF-6330
SWL
connection

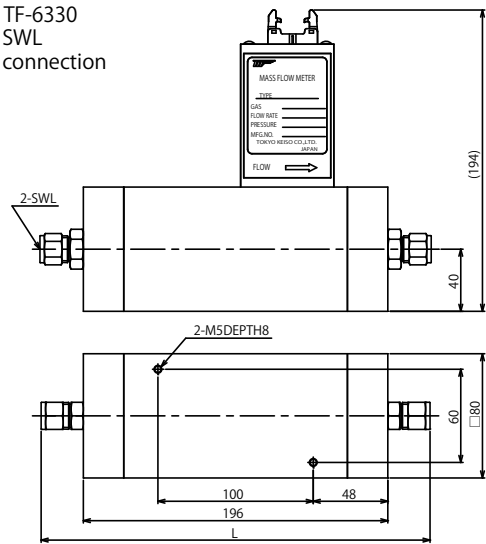

CONNECTION	L
1/4SWL	247
3/8SWL	250
1/2SWL	255
3/4SWL	266

TF-6340
Rc screw
connection

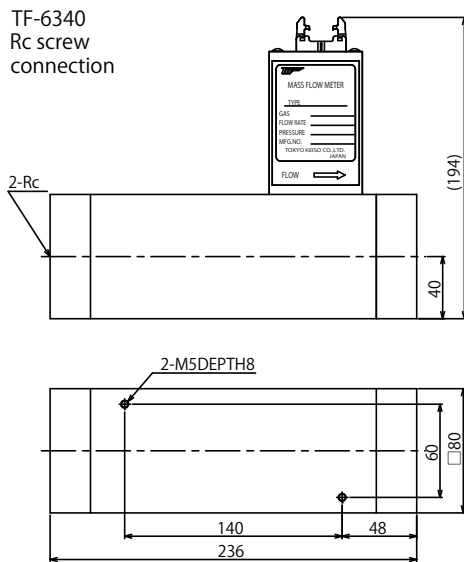

CONNECTION
Rc3/8
Rc1/2

TF-6340
SWL
connection

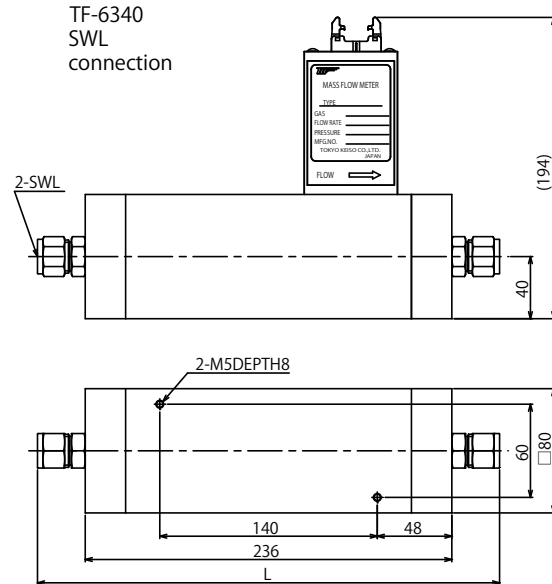

CONNECTION	L
3/8SWL	290
1/2SWL	295
3/4SWL	306

EXAMPLE OF MODEL SELECTION

The flow range is indicated as that of N₂ gas.

When measuring other gases, use the conversion factors (CF) shown below to convert the flow rate of the desired gas to that of N₂ and confirm that the selected model is appropriate for that measurement.

Formula for single-component gas

$$\text{Flow rate converted to that of N}_2 = \frac{\text{Flow rate of the gas specified by customers}}{\text{CF of the gas}}$$

Formula for mixed gas (gas with two or more components)

First, identify each CF of the component gases, calculate the CF of the mixed gas, and then convert its flow rate to that of N₂.

$$\text{CF of the mixed gas} = \frac{1}{\frac{X1}{CF1} + \frac{X2}{CF2} + \dots + \frac{X6}{CF6}}$$

X1 : Composition ratio of Component 1 (vol%/100)

X2 : Composition ratio of Component 2 (vol%/100)

⋮

X6 : Composition ratio of Component 6 (vol%/100)

CF1 : CF of Component 1

CF2 : CF of Component 2

⋮

CF6 : CF of Component 6

$$\text{Flow rate converted to that of N}_2 = \frac{\text{Flow rate of the mixed gas specified by customers}}{\text{CF of the mixed gas}}$$

CF of main gases

Fluid	Molecular formula	CF	Fluid	Molecular formula	CF
Nitrogen	N ₂	1.000	Nitrogen dioxide	NO ₂	0.740
Air	AIR	1.001	Nitrogen monoxide	N ₂ O	0.714
Argon	Ar	1.2 ^{*a}	Oxygen	O ₂	0.984
Carbon monoxide	CO	0.998	Methane	CH ₄	0.782
Carbon dioxide ^{*b}	CO ₂	0.745	Ethylene	C ₂ H ₄	0.623
Helium	He	1.404	Ethane	C ₂ H ₆	0.505
Hydrogen	H ₂	1.007	Propylene	C ₃ H ₆	0.407
Neon	Ne	1.403	Propane	C ₃ H ₈	0.351
Ammonia	NH ₃	0.769	n-butane	n-C ₄ H ₁₀	0.266
Nitric monoxide	NO	0.976			

*a : Use 1.4, not 1.2, for CF to convert the flow rate of Ar to that of N₂.

*b : Operating pressure is limited to 3 MPa at 30°C or more for CO₂ (TF-6300 Series).

Example: When the fluid is helium, the flow rate is 25 L/min (nor), pressure is 0.1 MPa, temperature is 20°C, and fitting is 1/4"SWL:

$$\text{Flow rate converted to that of N}_2 = \frac{25\text{L/min (nor)}}{1.404 \text{ (CF)}} = 17.8 \text{ L/min.(nor)}$$

Thus, TF-5310-253-S04 should be selected.

Cautions on use

- The mass flowmeter outputs flow rate signals from 0% to 100%. If the value in the lowest digit fluctuates too much at the zero point, set the low-cut at the converter. TM3000 (a dedicated converter) cuts off values of 2% or less as standard.
- When fluid flows in the opposite direction, the mass flowmeter outputs negative signals. To prevent this, install a check valve in the downstream of the flowmeter.
- The flow rate output characteristic of the mass flowmeter has been set to 5.000 [V] at the full-scale flow rate. If the flow rate exceeds the upper limit, the output of the flowmeter rises linearly at first but then declines gradually. To prevent this, use the flowmeter within the rated flow rates.
- Stop the flow of gas completely before adjusting the zero point. For details, see the Instruction Manual.
- Never allow gases that corrode SUS316 to flow through the flowmeter because the sensor capillary is made of SUS316TP.

Cautions on installation

- Since the sensor capillary has a small bore of $\phi 0.3$, it is easily blocked by dust and other foreign matter. Flush the piping thoroughly to remove foreign matter and moisture before mounting the flowmeter.
- For ammonia, DME, and other liquescent gases, install a filter in the upstream of the flowmeter.
- To avoid electrical noise, use shielded lines. Do not place them alongside other power lines.
- The arrow on the main body shows the correct direction of the flow for measurement. Install the flowmeter so that the measuring gas flows in this direction.
- The TF-6300 series (high-pressure type) must be installed horizontally.
- The TF-6300 series is used under high pressure, so the piping and the flowmeter may be cooled. To prevent measuring gases from liquefying, add insulation material or a tape heater on the piping or the flowmeter.
- The TF-5300 series and TF-6300 series do not need straight runs in both the upstream and downstream.

APPLICATION EXAMPLES

- Direct control by 0 to 5 V DC output
- Indication, Totalization...

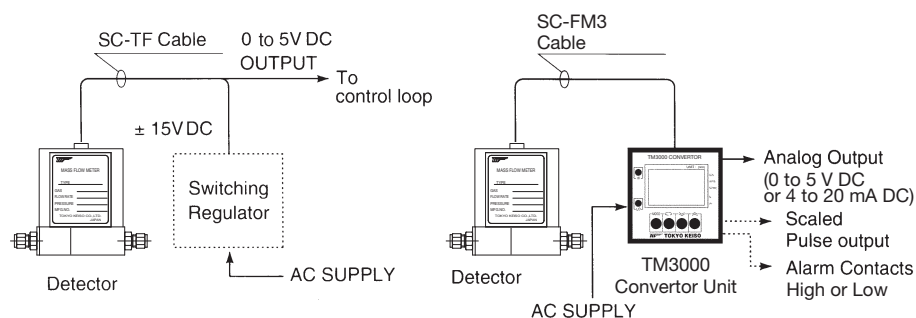

SUPPORTING INSTRUMENTS

- TM3000 convertor unit



*Refer to TM3000 catalog for details

- Connecting cable

Code	Connection	Standard length	Max. length
SC-TF	Between the TF detector and the commercially available power unit (output: 0 to 5 V DC)	2m	100m
SC-FM3	Between the TF detector and the TM3000 converter	2m	100m

* Specification is subject to change without notice.

TK TOKYO KEISO CO., LTD.

Head Office : Shiba Toho Building, 1-7-24 Shibakoen, Minato-ku, Tokyo 105-8558
 Tel : +81-3-3431-1625 (KEY) ; Fax : +81-3-3433-4922
 e-mail : overseas.sales@tokyokeiso.co.jp ; URL : <https://www.tokyokeiso.co.jp>